

DINE X

Dine X is a range of standalone rectangular tables and benches designed for dining, breakout or meeting areas. These industrial looking frames are very popular due to their sturdy features and amazing ability to suit every environment its designed for.

Table frames are 50mm thick box section steel while benches are 25mm x 50mm thick. With a huge range of RAL power coat finishes

and option of 25mm thick or 50mm thick HPL laminate tops, there is a way to create a bespoke product for every need.

Tables and Benches are available in lengths up to 3000mm, and tables can be 750mm or 1050mm high for working or dining applications.



STANDARD FEATURES

Welded mild steel frame in 50mm box section.
Frame covered with powder coated paint.
Either a 25mm thick or 50mm thick HPL Laminate top with MDF core.
Both tops complete with 2mm ABS edging.
Finished with stainless steel adjustable feet.



DESIGN By Senator

Our team of talented in house designers are responsible for creating elegant, innovative furniture designs which not only look beautiful, but minimise the impact on the world around us. personal taste.

They come from all over the world, but are based in our Design Centre located in a quiet Lancashire village just outside the Ribble Valley. Our dedicated facility is over three floors which include studios, a materials test centre and prototyping lab.

DIMENSIONS

**DINE X BENCH
WITH 50MM TOP**
380MM WIDE
425MM HIGH

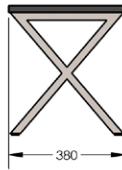

**DXB-8-38 to
DXB-28-38**
800 to 2800 Long

*Add '-2' for 25mm
thick laminate top*

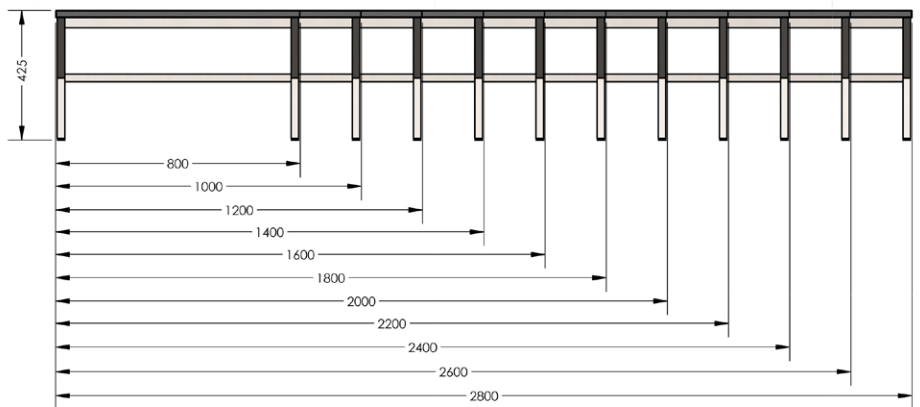

**DINE X BENCH
WITH 50MM TOP**
380MM WIDE
450MM HIGH

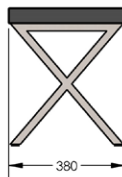

**DXB-8-38 to
DXB-28-38**
800 to 2800 Long

*Add '-5' for 50mm
thick laminate top*

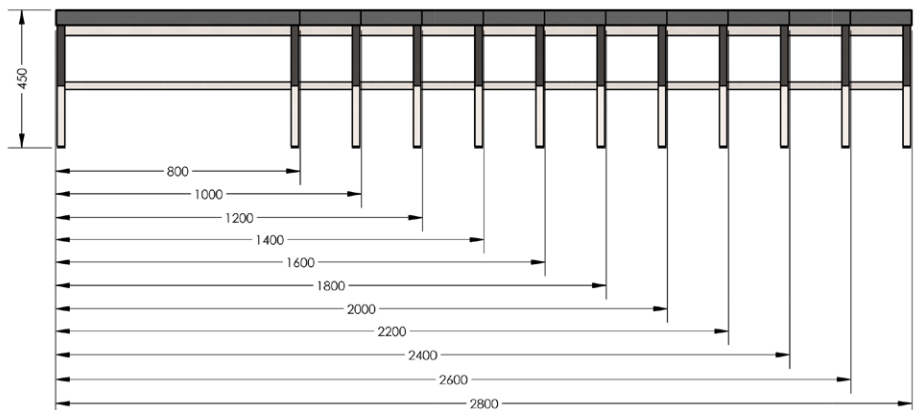

DIMENSIONS

**DINE X TABLE
WITH 25MM TOP**
750MM WIDE
725MM HIGH

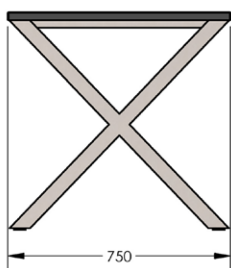
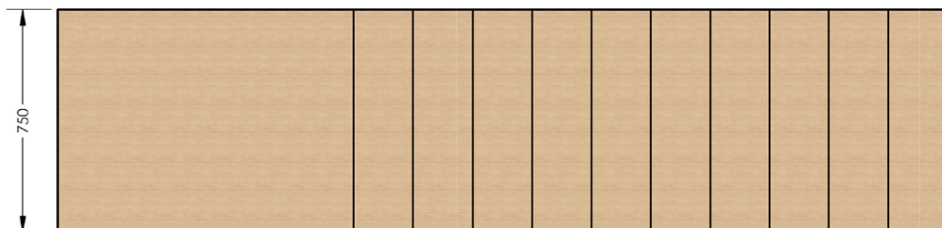

**DXT-10-75 to
DXT-30-75**
1000 to 3000 Long

*Add '-2' for 25mm
thick laminate top*

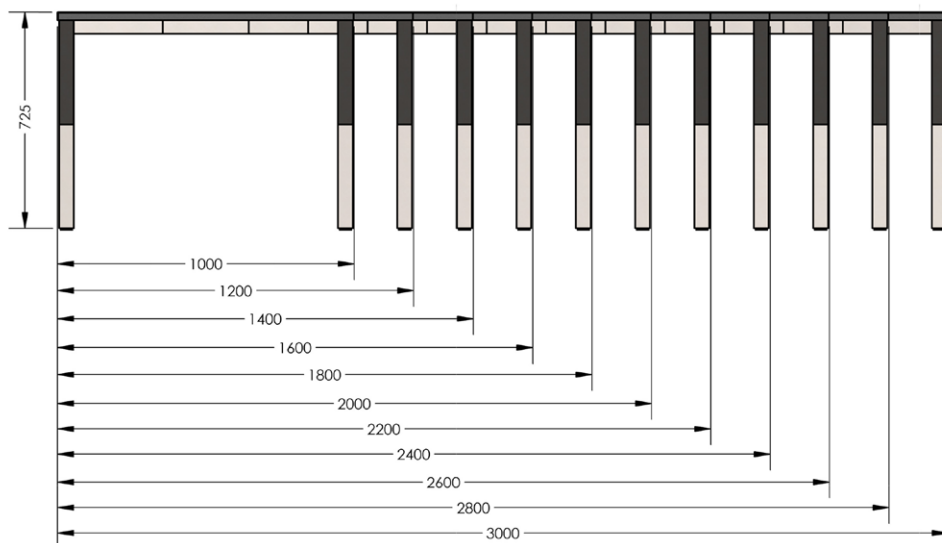

**DINE X TABLE
WITH 50MM TOP**
750MM WIDE
750MM HIGH

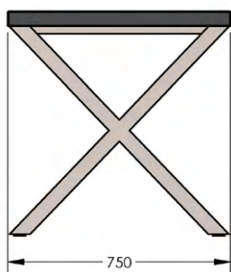

**DXT-10-75 to
DXT-30-75**
1000 to 3000 Long

*Add '-5' for 50mm
thick laminate top*

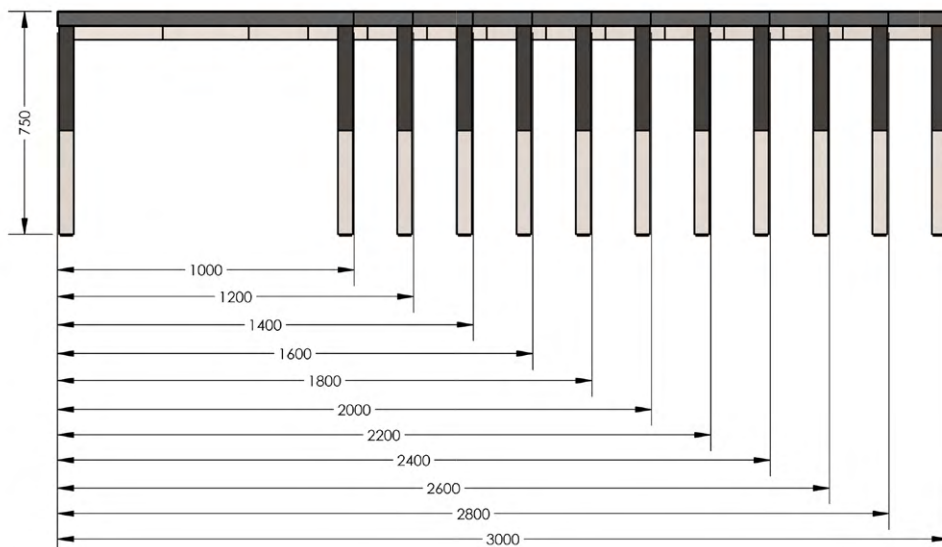

DIMENSIONS

**DINE X TABLE
WITH 25MM TOP**
1000MM WIDE
725MM HIGH

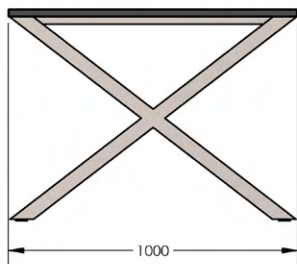

**DXT-10-10 to
DXT-30-10**
1000 to 3000 Long

*Add '-52 for 25mm
thick laminate top*

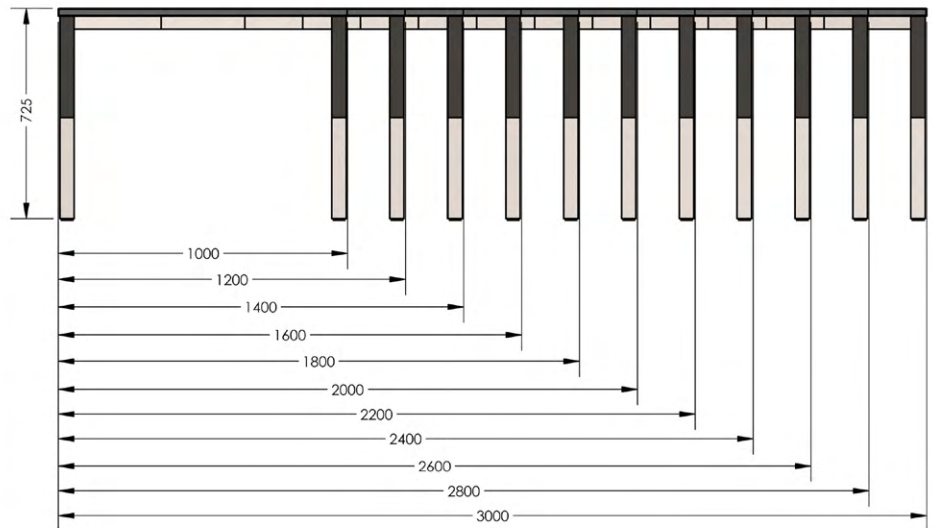

**DINE X TABLE
WITH 50MM TOP**
1000MM WIDE
750MM HIGH

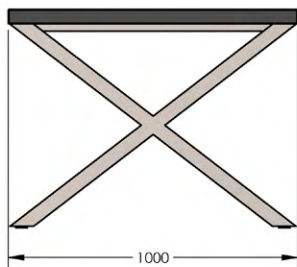

**DXT-10-10 to
DXT-30-10**
1000 to 3000 Long

*Add '-5' for 50mm
thick laminate top*

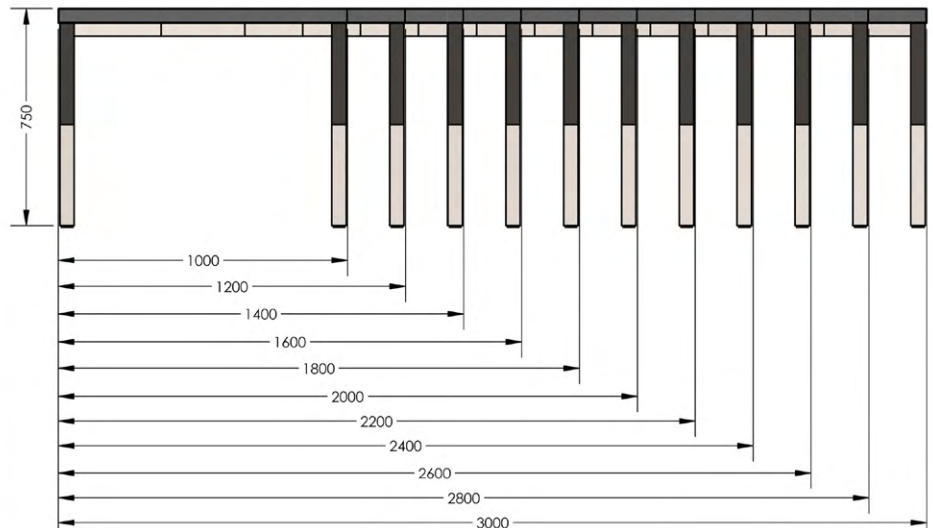
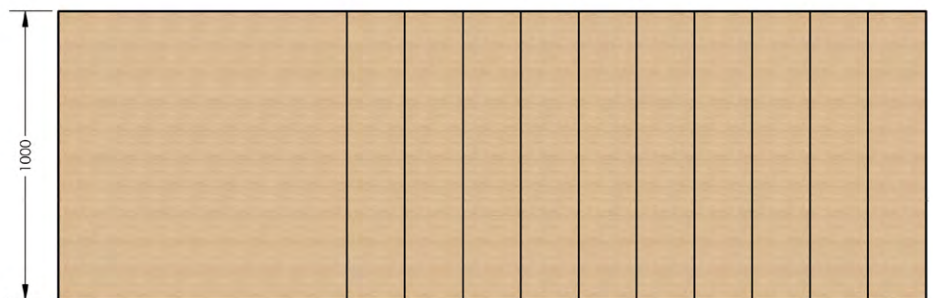

DIMENSIONS

**DINE X TABLE
WITH 25MM TOP**
1200MM WIDE
725MM HIGH

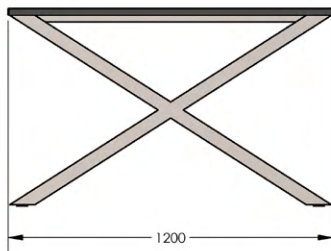

**DXT-10-12 to
DXT-30-12**
1000 to 3000 Long

*Add '-2' for 25mm
thick laminate top*

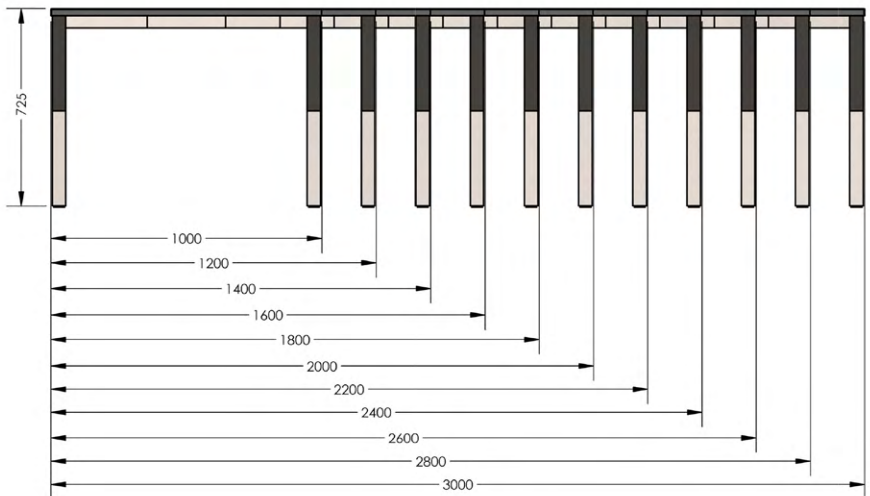

**DINE X TABLE
WITH 50MM TOP**
750MM WIDE
1050MM HIGH

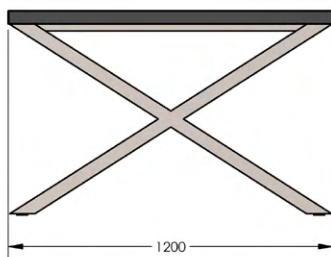
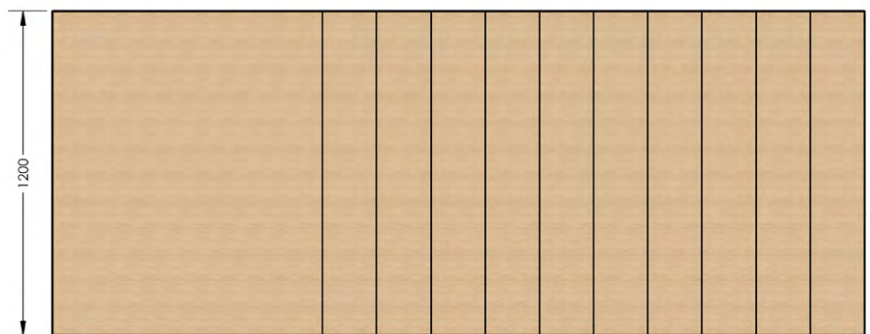

**DXT-10-12 to
DXT-30-12**
1000 to 3000 Long

*Add '-5' for 50mm
thick laminate top*

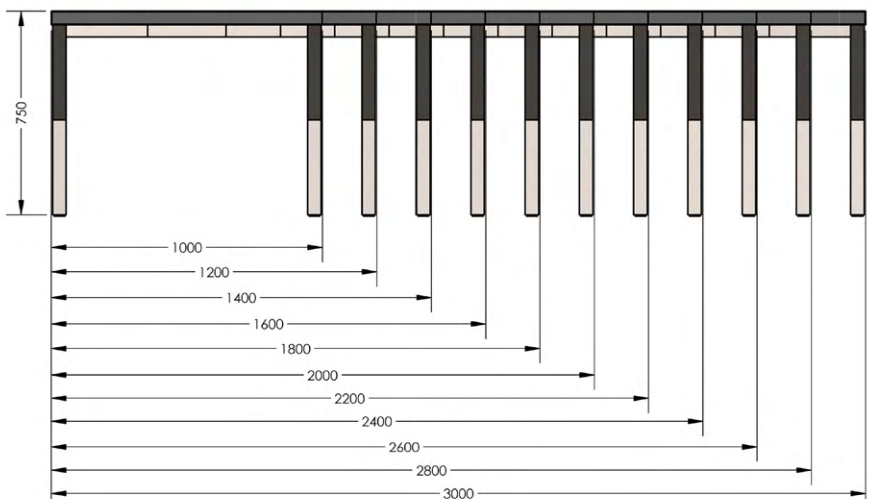

DIMENSIONS

DINE X POSEUR TABLE WITH 25MM TOP

750MM WIDE
1025MM HIGH

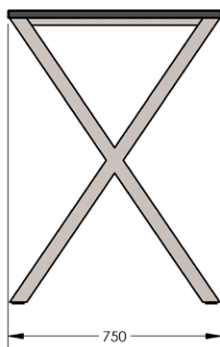

DXP-10-75 to
DXP-30-75
1000 to 3000 Long

*Add '-2' for 25mm
thick laminate top*

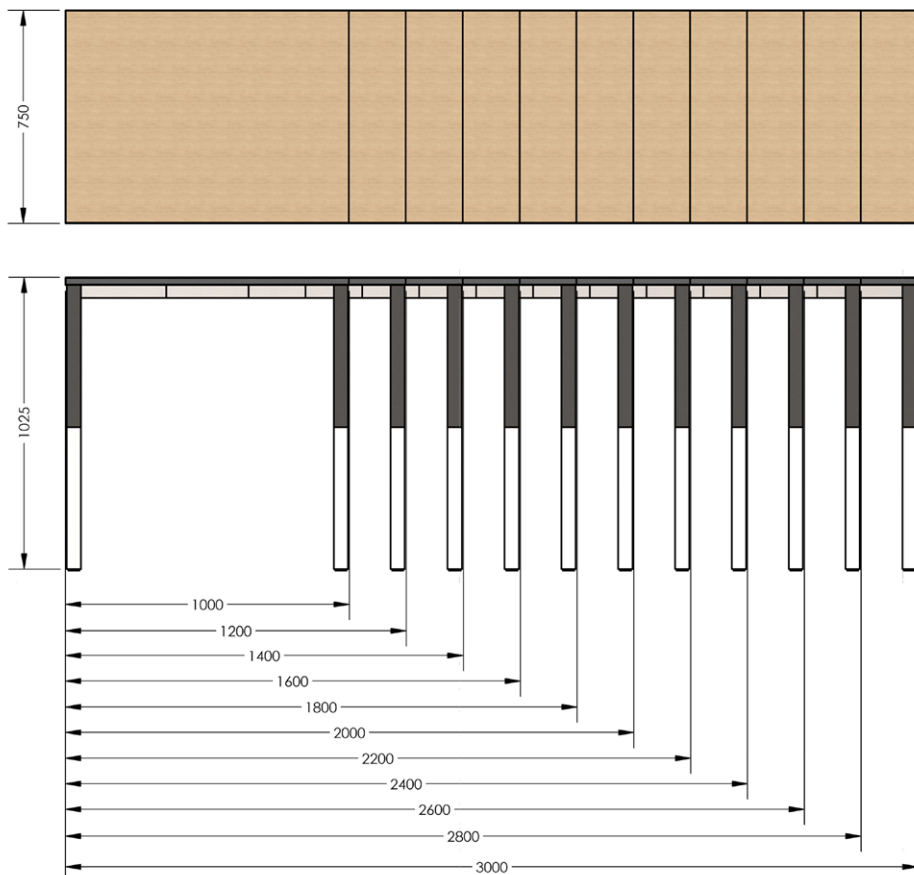

DINE X POSEUR TABLE WITH 50MM TOP

750MM WIDE
1050MM HIGH

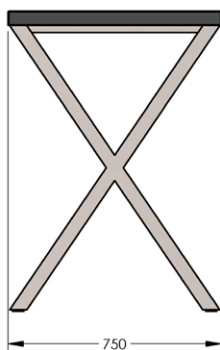

DXP-10-75 to
DXP-30-75
1000 to 3000 Long

*Add '-5' for 50mm
thick laminate top*

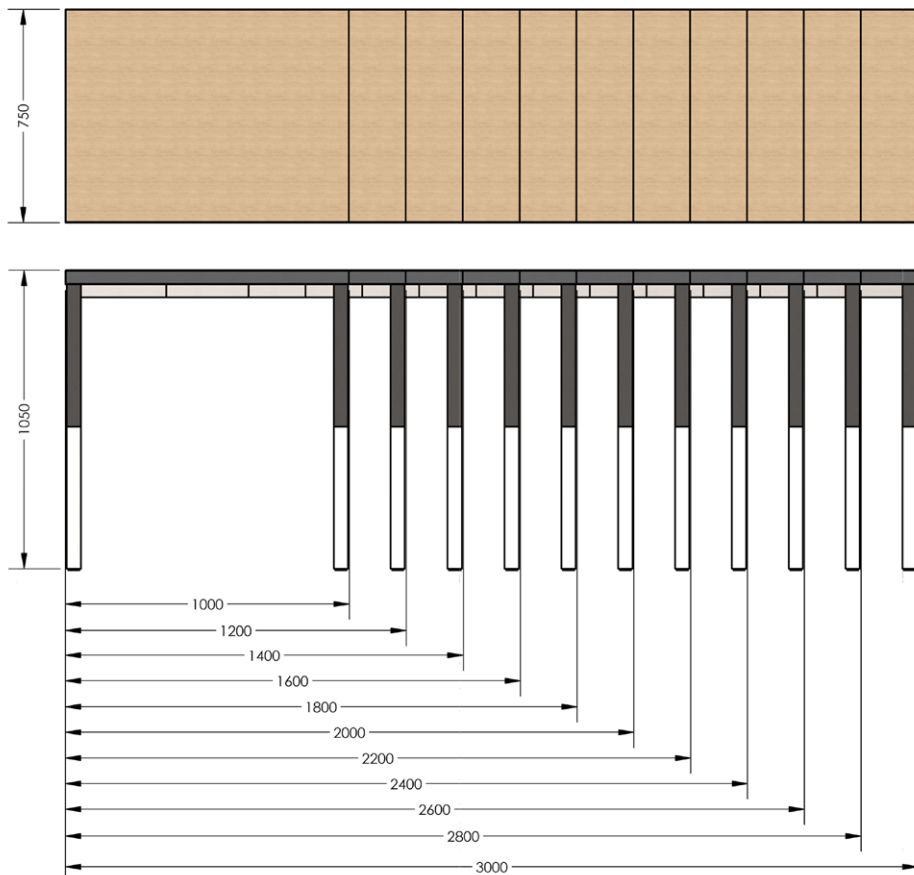

DIMENSIONS

**DINE X POSEUR TABLE
WITH 25MM TOP**
1000MM WIDE
1025MM HIGH

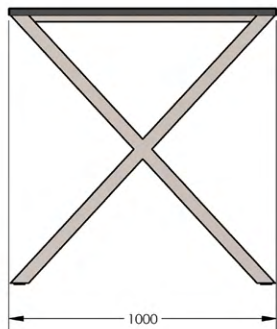

**DXP-10-10 to
DXP-30-10**
1000 to 3000 Long

*Add '-2' for 25mm
thick laminate top*

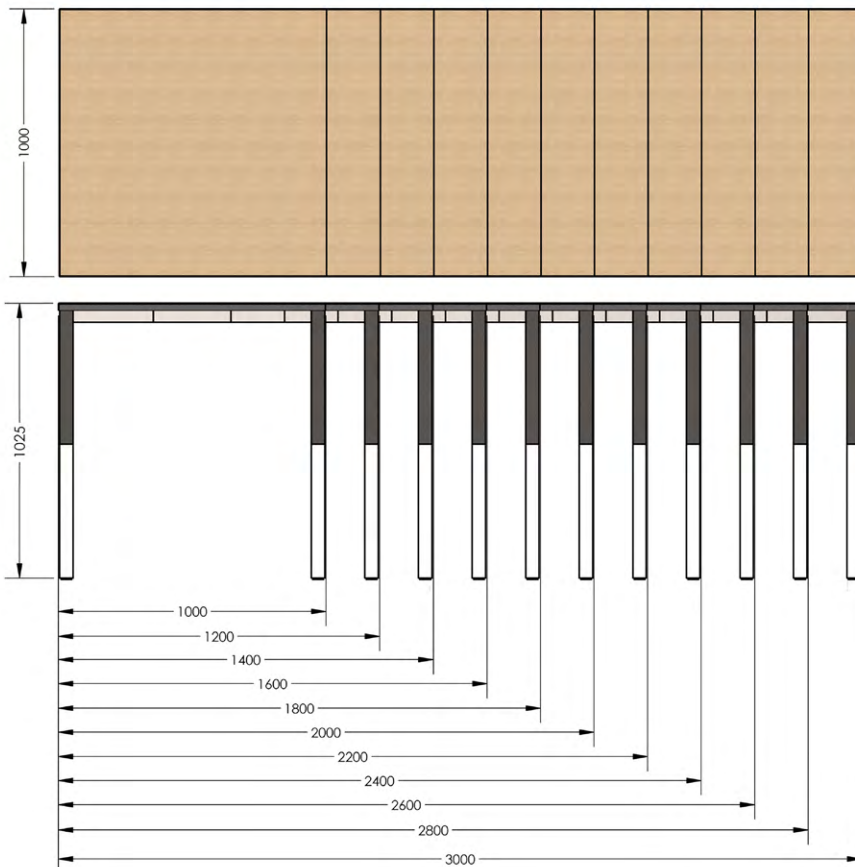

**DINE X POSEUR TABLE
WITH 50MM TOP**
1000MM WIDE
1050MM HIGH

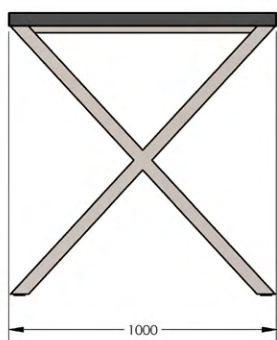

**DXP-10-10 to
DXP-30-10**
1000 to 3000 Long

*Add '-5' for 50mm
thick laminate top*

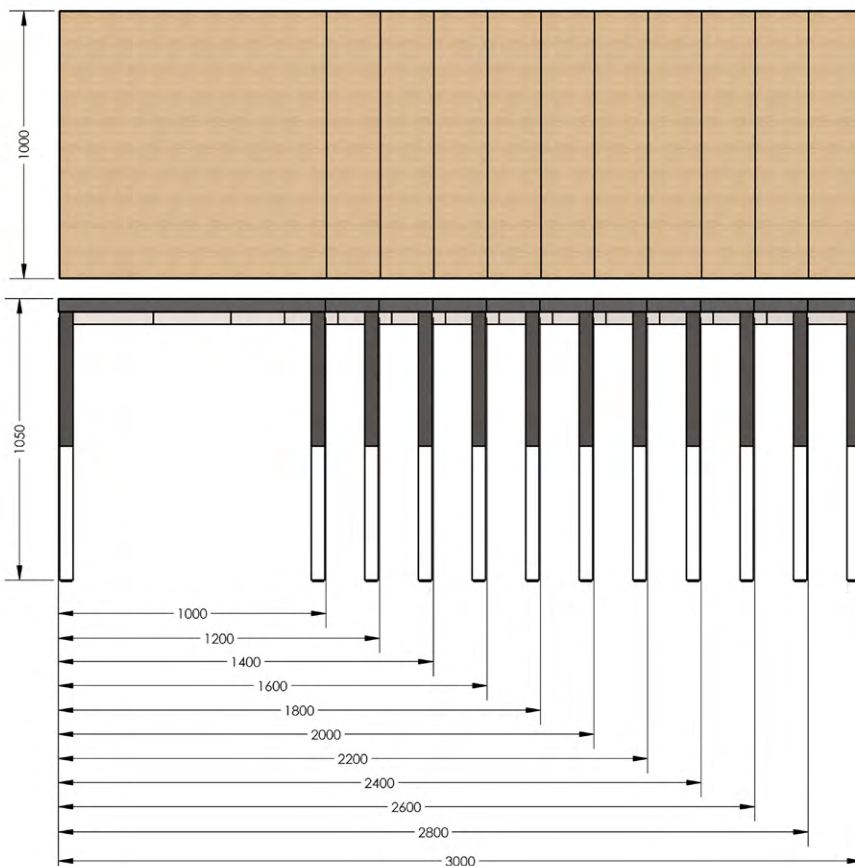

DIMENSIONS

**DINE X POSEUR TABLE
WITH 25MM TOP**
1200MM WIDE
1025MM HIGH

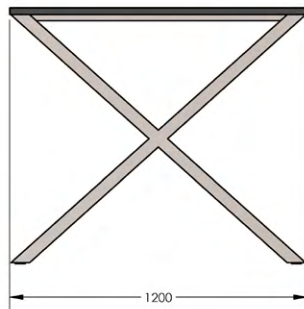

**DXP-10-12 to
DXP-30-12**
1000 to 3000 Long

*Add '-2' for 25mm
thick laminate top*

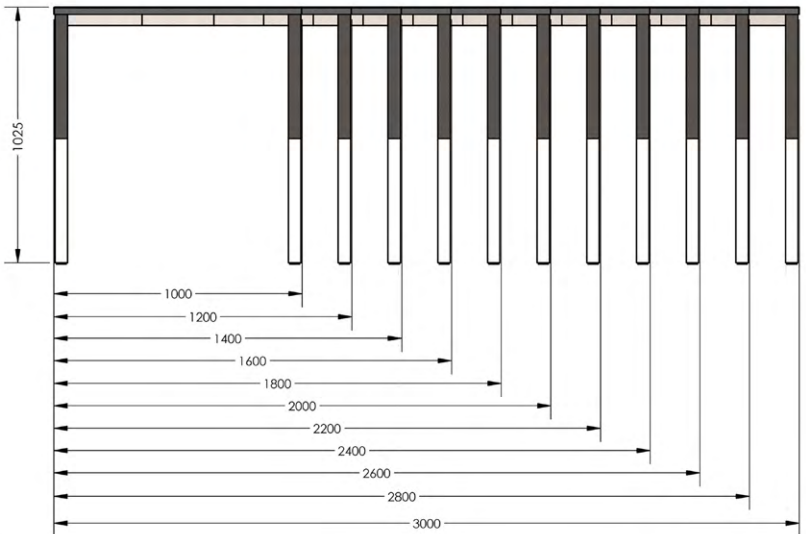
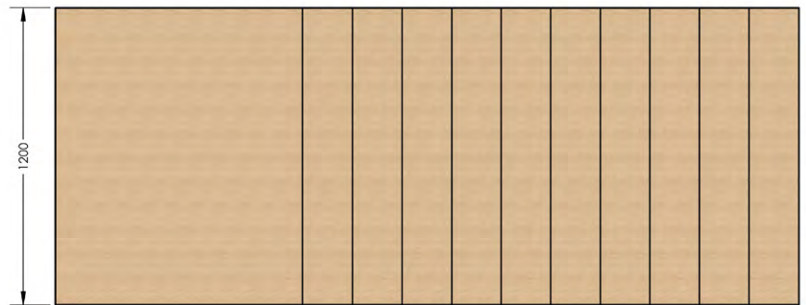

**DINE X POSEUR TABLE
WITH 50MM TOP**
1200MM WIDE
1050MM HIGH

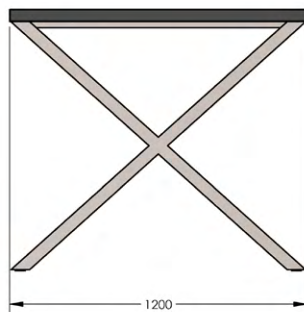

**DXP-10-12 to
DXP-30-12**
1000 to 3000 Long

*Add '-5' for 50mm
thick laminate top*

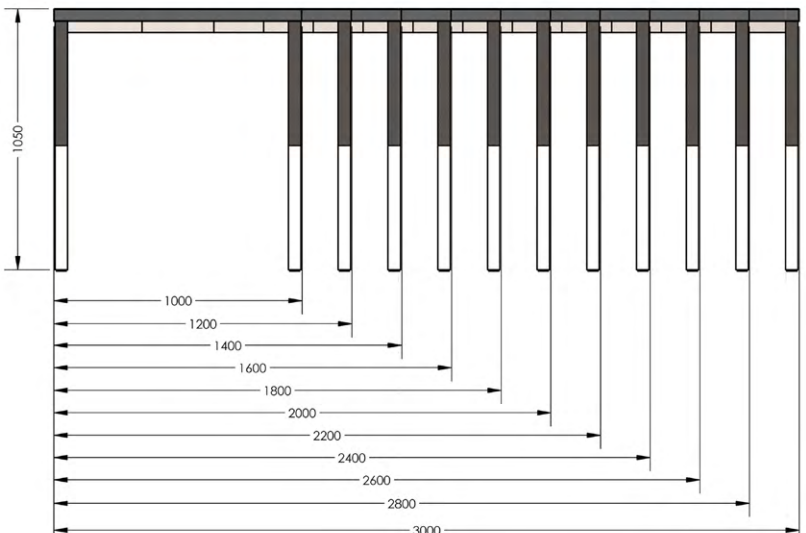
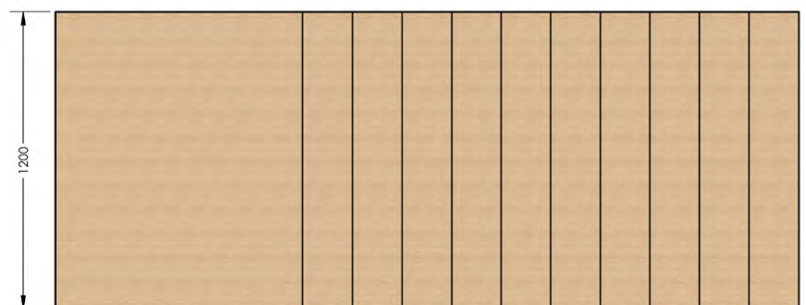

METAL FRAME FINISHES



WHITE
Smooth

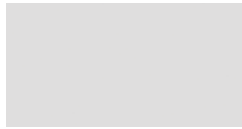

SILVER
Smooth



SILVER/M04
Chrome Effect - Smooth



BRONZE
Smooth



BLACK
Smooth



SLATE GREY
Fine Texture

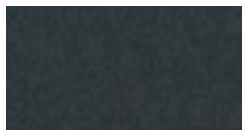

TOUCH OF GREY
Fine Texture



VINTAGE RED
Fine Texture



CORAL RED
Fine Texture

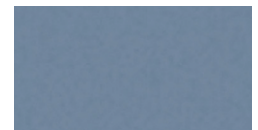

BLUE SKIES
Fine Texture



MELLOW YELLOW
Fine Texture



BACK TO BLACK
Fine Texture



MINERAL NIGHT
Fine Texture

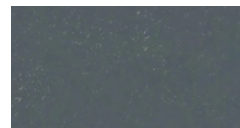

MINERAL STONE
Fine Texture



MINERAL FOREST
Fine Texture



MINERAL OLIVE
Fine Texture

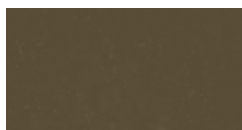

MINERAL CLAY
Fine Texture



MINERAL BERRY
Fine Texture



MINERAL SPICE
Fine Texture

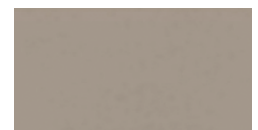

MINERAL SAND
Fine Texture

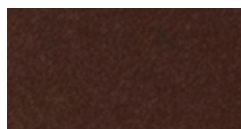

OXIDE 1
Fine Texture



ZINC YELLOW
Fine Texture



TRAFFIC ORANGE
Fine Texture



TURQUOISE BLUE
Fine Texture

Clear lacquer is also available as a standard product.

Colour Disclaimer: Printed images and digital images may appear differently to the final Metal finish.

ENVIRONMENTAL

Material Content

Components are constructed of the following

Dine X Bench



MDF



Steel



Stainless Steel

Dine X Table



MDF



Steel



Stainless Steel

Recycled Content

Contains up to 47.65% or 46.40% of recycled material



Recycled Content (% By Weight)



Recycled Content (% By Weight)

Recyclability

The range is 99% recyclable

99%

99%

SENATOR 3 R'S

Senator is committed to continually improving the sustainability of all environmental aspects within our business.

To meet both international standards and our own environmental targets we apply the three R's principle

-Reduce, Reuse and Recycle.

Whilst recycling is the element which receives the most exposure it is actually the last option available and should never be the prime target in anyone's battle to reduce waste.

It is our duty as individuals and as a company to initially attempt to **Reduce** usage. Then we should look to **Reuse** wherever possible and finally, only after these two processes have been exhausted, should we consider **Recycling**.

Reduce
Reuse
Recycle